

TRISTAR

Digital Meters

Installation and Operation Manual

Version: TS-M
Version: TS-RM



1098 Washington Crossing Road
Washington Crossing, PA 18977 USA
phone: 215.321.4457
fax: 215.321.4458
email: info@morningstarcorp.com
www.morningstarcorp.com

Table of Contents

Important Safety Instructions	ii
1.0 Meter Description	1
1.1 Meter Versions.....	1
1.2 General Use	2
2.0 Installation	3
2.1 General Information	3
2.2 TS-M Installation	3
2.3 TS-RM Installation.....	4
2.4 Meter Selections and Confirmations	5
3.0 Operation	7
3.1 Display Structure.....	7
3.2 Meter Display Charts	8
3.3 Backlighting	8
3.4 Operating Displays.....	11
3.5 Manual Operations.....	12
4.0 Diagnostics	14
4.1 Locate Diagnostics	14
4.2 Faults & Alarms Displayed.....	14
4.3 Using the Diagnostic Data.....	15
5.0 TriStar Settings	17
5.1 Locate System Settings	17
5.2 Information Displayed	17
5.3 Language and Temperature Selections	17
6.0 Troubleshooting the Meter	19
6.1 Troubleshooting Steps.....	19
6.2 Repair RJ-11 Connection	20
7.0 Warranty	22
8.0 Specifications	23

IMPORTANT SAFETY INSTRUCTIONS

SAVE THESE INSTRUCTIONS:

This manual contains important safety, installation and operating instructions for the TriStar meters.

The following symbols are used throughout this manual to indicate potentially dangerous conditions or important safety instructions.



WARNING: Indicates a potentially dangerous condition. Use extreme caution when performing this task.



CAUTION: Indicates a critical procedure for safe and proper operation of the controller.



NOTE: Indicates a procedure or function that is important to the safe and proper operation of the controller.

General Safety Information

- Read all the instructions and cautions in the manual before starting the installation.
- There are no user serviceable parts in the meters. Do not disassemble or attempt to repair the meter.
- Ensure that both the battery and the solar power have been disconnected before installing or disconnecting the meter.
- There are no fuses or user replaceable parts in the meters.
- Do not allow water to enter the meter.

1.0 Meter Description

The TriStar is a technically advanced and professional solar system controller. Two digital LCD meter versions are available for the TriStar controller, and their displays are identical. One version is mounted on the controller, the other is for remote locations.

This manual will help you to become familiar with the TriStar meters features and capabilities. Some of these follow:

- **UL Recognized for use with TriStar controllers**
- **Complies with CE and LVD standards**
- **Suitable for 12, 24, 48 Vdc systems**
- **Fully protected from wiring faults**
- **Can be added to a TriStar at any time**
- **Controller-mounted and remote meter versions can be used together**
- **Nonvolatile memory will retain settings with no power**
- **Extended LCD temperature rating (-20°C to +70°C)**
- **Multilingual display (English, French, German, Portuguese, Spanish)**
- **Provides for manual resets**
- **Diagnostic capabilities with informative displays**
- **Confirmation of the TriStar controller settings**
- **Remote version supplied with 30m (98.4 ft) connecting cable**
- **Connections are by standard RJ-11 6-position modular plugs**
- **5-year standard warranty**

1.1 Meter Versions

This manual describes two standard versions of a 2x16 digital LCD meter that can be used with the TriStar solar controller:

Version TS-M:

This local meter is provided as an assembly that replaces the TriStar front access cover. The TS-M meter mounts to the TriStar controller.

Version TS-RM:

This remote meter is provided with a mounting plate and 30m (98.4 ft) of cable. It is identical to the TS-M version except that the TS-RM version can be mounted at some distance from the controller.

continued...

1.1 Meter Versions *continued...*

Both meters display a full range of operating and diagnostic information for the TriStar's battery charging, load, and diversion operating modes. This manual will generally describe the solar battery charging mode with notes where the load or diversion mode displays are different.

1.2 General Use

The meter will display a great deal of information about the TriStar controller and the operation of your system. In addition, the meter enables manual functions and controller diagnostics. These capabilities will increase your confidence that the system is working properly and will help you to improve system reliability, battery life, and system performance. It is worth the time getting to know your meter!

The organization of the display screens is described in Section 3.1. It is easy to move around the various display areas and to scroll up or down, and left or right using the four pushbuttons as indicated below:



LEFT



RIGHT



UP



DOWN

There is a limit of two meters that can be used with a single TriStar controller. Both can be remote, or one local and one remote. Only one meter is able to have backlighting at any given time.

2.0 Installation

The TriStar meters can be added to the controller when it is first installed, or at anytime after the controller has been in service.

2.1 General Information

The meter installation involves two or three steps:

- Mount the meter to the TriStar (TS-M) or at a remote location (TS-RM).
- Connect the meter cable to the RJ-11 connectors.
- Select a different language or temperature display (optional)

All information displayed by the meter is provided by the TriStar controller. No adjustments to the meter are required. Everything is automatic.

Both meters are rated for indoor use only.

There is a limit of two meters per TriStar. A single TriStar controller cannot power three meters. Two TriStar controllers cannot be connected to a single meter.

To replace or extend the remote meter cable, see *Section 6.0*.

2.2 TS-M Installation

To install the controller-mounted meter, follow these steps in order:



NOTE: *Disconnect all power to the TriStar. The meter will not be damaged if connected with power, but power should be disconnected whenever the access cover is removed for safety.*

1. Use a phillips screwdriver to remove the TriStar's four access cover screws.



CAUTION: *Be careful that the access cover does not hang or dangle from the RJ-11 cable. The resulting stress on the cable could damage the meter or the connectors. The cable is short to help prevent such stress.*

continued...

2.2 TS-M Installation *continued...*

2. Connect the cable to the RJ-11 socket on the TriStar, and then to the meter. Looking at the back of the meter, connect to the left RJ-11 socket.

Note that if the cable is connected to the wrong RJ-11 meter socket, there will not be any damage and the LCD display will remain blank. Move the cable connection to the other socket.

3. Carefully mount the TS-M cover on the controller and fasten the 4 screws.

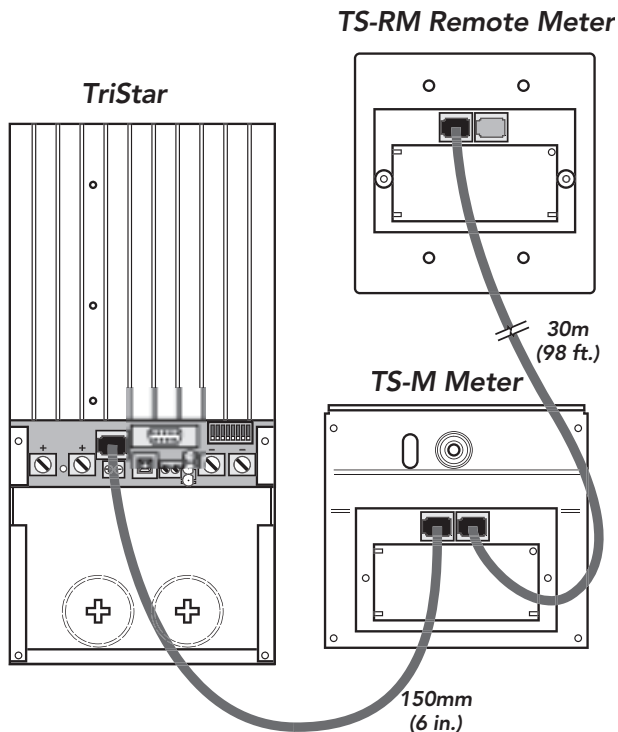

Meter Connections Figure 2.1



CAUTION: Do not force the cover into place. If the large power wires are too high in the wiring compartment, pushing the meter down onto the wires will damage the meter.

2.3 TS-RM Installation

The remote meter is designed to mount into a standard duplex (2-gang) electrical box, or flush against a wall or cabinet with a correctly sized mounting hole.

1. Connect one end of the 30 meter cable to the TriStar RJ-11 socket (or to the open socket on the TS-M meter if one is mounted to the TriStar). See *Figure 2.1*.
2. Connect the other end of the cable to the left socket (looking at the back) of the remote meter. See *Figure 2.1*.
3. Confirm the meter is working before mounting the meter (TriStar power must be on). If not working, connect the cable to the other RJ-11 socket.
4. Mount the meter to the wall or cabinet. If a 2-gang box is not being used, cut a hole in the wall or cabinet sized per *Figure 2.2* (next page).

Note that two remote meters can be connected to a single TriStar controller if a TS-M meter is not attached to the controller. Refer to *Figure 2.1*. The connections will be the same.

2.4 Meter Selections and Confirmations

This final installation step can be used to select another language or to change the temperature displays from °C to °F. See *Section 5.3* for more information.



NOTE: The first press of a meter pushbutton will only turn on the backlight. The meter display will not change.

1. Press the pushbutton to scroll down to "TriStar Settings".

continued...

2.4 Meter Selections and Confirmations *continued*

2. Press the \triangleright pushbutton and then scroll down to the display for changing the language. Select one of the four languages if other than English is desired.
3. Move down to the next display for changing temperature units from °C to °F. If a change to °F is desired, follow the directions in the display.
4. The other "Settings" displays can be used to confirm that the TriStar DIP switch settings are correct.
5. Return to one of the top three operating displays.

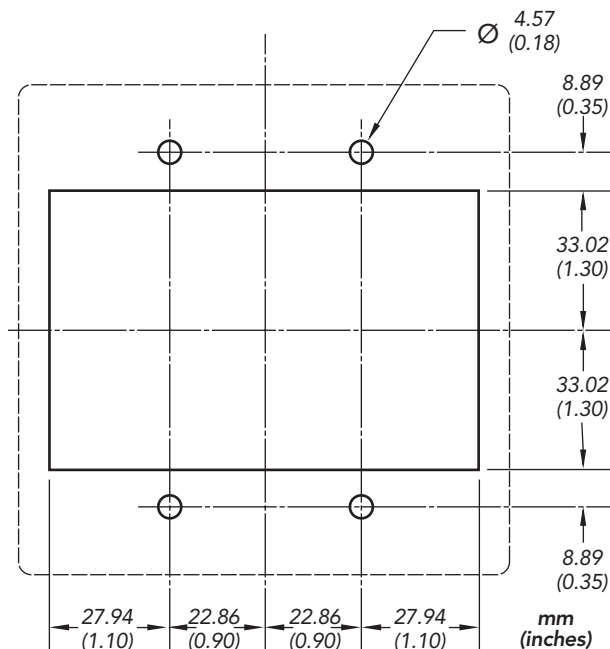

Remote Meter Mounting Figure 2.2

3.0 Operation

The four pushbuttons are in the shape of directional arrows. Changing a display screen will be in the direction of the arrow (up or down / left or right).

The meter can be left in any display screen, but it is recommended to use one of the top three operating displays for useful system information.

There are two initial screens (TriStar version and serial number) that are only displayed at start-up. This information can also be found under "TriStar Settings" during normal operation.

Solar Charging mode will be used in this manual to illustrate general meter displays. The displays for Load and Diversion are similar to Solar Charging.

3.1 Display Structure

There are over 30 display screens that can be selected with the four pushbuttons. These displays are organized into four functional groups to make it easy to access the display you need. Refer to the charts in Section 3.2 that show the complete set of meter displays.

First Group: Operating Displays

Three displays provide real-time operating figures, volt/amp bar charts, and cumulative operating figures. Using the ◀▶ pushbuttons, each of these three display screens can be quickly accessed.

Second Group: Manual Operations

The next two display screens provide for frequently needed manual operations. These include resetting amp-hours and high/low battery voltage, starting and stopping battery equalization, and LVD (low voltage load disconnect) override in load mode.

Third Group: Diagnostics

The next screen enters a section of diagnostic displays. This area indicates faults or alarms, and real-time operating data for the controller. At the bottom of this group are less frequently used manual operations.

continued...

3.1 Display Structure *continued...*

Fourth Group: TriStar Settings

The final group of displays describe the TriStar settings. This includes reference information to verify the settings selected for the controller, the software and hardware versions, and the TriStar serial number. At the bottom of this group are user selections for temperature display and language.

3.2 Meter Display Charts

The next two pages exhibit the Solar Charging and Load Control display charts. Diversion is similar to Solar Charging. These charts can be useful for locating specific display screens. The four groups of displays discussed above are identified in the display charts.

3.3 Backlighting

The first push of any of the four meter pushbuttons will turn on the backlight. The backlight will remain on for 5 minutes from the last button press.



NOTE: *When turning on the backlight, there is no change in the display. The second press of any pushbutton will then change the display screen. This applies to both TS-M and TS-RM meter versions.*



NOTE: *Only one meter will be backlit at a time. Pushing a button on a second meter will automatically turn off the backlight on the first meter.*

If the battery voltage falls below 12.7V, the backlighting will begin to dim. Backlighting will continue to dim proportionally to the battery voltage down to 10.0V. Below 10 volts the backlighting will begin to cycle, which could cause backlighting conflicts with two meters installed. The lower voltage limit for the meter is 9.3V. If the voltage falls below 9V, the meter display will turn off.

The backlight draws very little current. The backlighting would have to be turned on more than 28 hours to consume 1 Ah of energy.

SOLAR CHARGING

Operating Displays
(Section 3.4)

13.5v	25c	12.3A	V		14.4V	11357Ah
1234.5Ah	FLOAT	A	A		12.3V	11.3kWh

Manual Operations
(Section 3.5)

Reset Ah (Hold → 2 sec)
Equalize START (Hold → 2 sec)

Diagnostics
(Section 4.0)

Diagnostics (Press →)

TriStar Settings
(Section 5.0)

TriStar Settings (Press →)

(← to Return) TriStar Settings
TS-60 v01.01.01 Serial: 03010001
Meter v01.01.01
Mode: Charge 12v (Auto)
Battery Type: 5 Float: 13.40v
Regulation: 14.40V PWM
Equalize: 15.15V Automatic 28d
Language: ←English→
Units: ←°C→

(← to Return) Diagnostics
Faults:←1 of 3→ HVD
Alarms: NONE
Battery --°C 14.35V 10.30A
Battery Sense 14.40V valid
State: PWM10% Solar: 17.70V
Last Eq: 13d
total: 11357Ah reset: 1234.5Ah
TriStar: 35°C 123456 hours
Battery Service 13d (→2s reset)
Reset Ah total (Hold → 2sec)

LOAD

Operating Displays
(Section 3.4)

13.5v	25c	12.3A	V		14.4V	11357Ah
1234.5Ah	NORMAL	A	A		12.3V	11.3kWh

Manual Operations
(Section 3.5)

Reset Ah
(Hold → 2 sec)

Turn Load OFF
(Hold → 2 sec)

Diagnostics
(Section 4.0)

Diagnostics
(Press →)

TriStar Settings
(Section 5.0)

TriStar Settings
(Press →)

(← to Return)

TriStar Settings	
TS-60	v01.01.01
Serial:	03010001
Meter	v01.01.01
Mode:	Load
	12v (Auto)
Battery Type:	5
LVD:	11.9V
LVR:	13.4V
Language:	←English→
Units:	←°C→

(← to Return)
Diagnostics

Faults:←1 of 3→ Overcurrent
Alarms: NONE
Battery 13.23V 12.34A
Battery Sense 13.51V valid
State: NORMAL Load: 14.35V
total: 11357Ah reset: 1234.5Ah
TriStar: 35°C 123456 hours
Reset Ah total (Hold → 2sec)

3.4 Operating Displays

A few seconds after the TriStar is powered-up, one of the following screens will be displayed:



These display screens are configured in a continuous circular loop and can be quickly accessed by scrolling either left or right.

The **first display** (below), provides general operating information. For battery charging, this information includes:

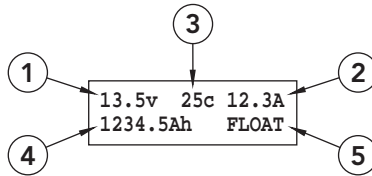

1. Battery voltage
2. Battery current
3. Battery temperature (only if the remote temperature sensor (RTS) is installed)
4. Amp-hours generated (since the last reset)
5. Present operating state (NightCHECK / DISConnect / NIGHT / FAULT / BULK / PWM00% / FLOAT / EQUILIZ). A Fault indication will blink on and off. An Alarm indication will alternate with the present state.

Operating status conditions for Load mode are: NORMAL / LVDWARNING / LVD / FAULT / DISConnect.

The **second display** (below), provides bar graphs for battery voltage and charging current.



Fault, Alarm, and Battery Service will blink in the lower right corner if one of these conditions is present.

The **third display** (below), provides cumulative information, collected over time. For battery charging, this includes:

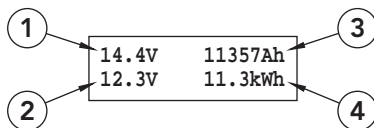

1. Highest battery voltage (resets with Ah reset)
2. Lowest battery voltage (resets with Ah reset)
3. Total amp-hours generated by the system
4. Total kWh's generated by the system

Fault, Alarm, and Battery Service will blink in the lower right corner if one of these conditions is present.



NOTE: The cumulative meter information will be retained if the controller power is disconnected.

Also note that the amount of CO₂ saved by the solar energy can be calculated from the total kWh generated: 1 kWh \approx 1 kg (2.2 pounds) of CO₂ saved. These figures are for coal and petroleum generated electricity delivered to the home.

3.5 Manual Operations

Display screens located below the operating displays and also in the Diagnostic group provide for various resets and manual functions. These are shaded in the Meter Charts.

3.5.1 Manual Resets

A frequently used manual reset is located below the operating displays:

Reset Ah: This display screen can be used to reset the Ah value indicated on the first operating display (the "resettable" Ah). This will also reset the High & Low battery voltages in the third operating display at the same time. Hold the  pushbutton for 2 seconds and all three values will be reset to zero.

Two other manual resets can be found at the bottom of the “Diagnostics” screens:

Reset Ah Total: This will reset the total Ah and total kWh values to zero. These values are normally not reset. However, if a new battery is installed for example, the owner may wish to reset these figures. Note that once these are reset, the previous total Ah and total kWh values are lost.

Battery Service: If battery service was done early, this screen can be used to reset the service interval back to zero.

3.5.2 Manual Equalization (or Load Control)

The display screen below “Reset Ah” will start an equalization cycle. While in equalization, holding the  pushbutton again for 2 seconds will stop the equalization cycle. This can be repeated without limit.

Battery equalizations are typically a very important element of battery service and life. A manual equalization can serve many purposes:

- continue beyond the programmed equalization cycle if the battery requires additional equalization
- perform an early equalization cycle before the automatic cycle begins (resets the automatic cycle)
- equalize Diversion batteries (can only be done manually unless made automatic using the PC software)
- level battery cell voltages

Note that in the **Load Control** mode, this display screen can be used to reconnect loads for 10 minutes after a low voltage load disconnect (LVD). There is no limit to LVD reconnects. In addition, pressing the right pushbutton in a normal operating mode will toggle the load on and off.

4.0 System Diagnostics

The TriStar meter can be used to troubleshoot both the controller and problems with the solar system.

4.1 Locate Diagnostics

Scroll down to the display screen "Diagnostics". Press the  pushbutton to reach the subset of displays with diagnostic information. In addition to Faults and Alarms, many system operating parameters are also displayed. Use the up and down pushbuttons to scroll through the display screens.

To return to the primary meter displays, scroll up to the top of the Diagnostics displays, and then press the  pushbutton to return to the main Diagnostic screen. Then scroll up to the top three operating displays.

4.2 Faults & Alarms Displayed

In the event a Fault or Alarm condition has been detected by the TriStar, "FAULT" or "ALARM" will be indicated in the top three operating displays. Moving the meter display down to the Diagnostic displays, the specific fault or alarm condition will be identified. Use the  pushbutton to display each specific problem.

A **Fault** causes automatic protection and the current switches (FET's) will open. The **Faults** that can be displayed include the following:

- "External Short" — external short circuit
- "Overcurrent" — current exceeds rating
- "RTS shorted" — remote temperature probe short circuit
- "RTS disconnected" — RTS was working but is now disconnected
- "FET Short" — FET switches are shorted closed
- "Software" — a software problem
- "HVD" — a high voltage disconnect
- "TriStar hot" — heat sink temperature exceeded limits
- "DIP sw changed" — a DIP switch changed while running or a setting error
- "Setting edit" — an EEPROM setting was edited while running

- “Reset?” — a reset due to an interrupted fault (typically power cycle)
- “Miswire” — a system wiring fault

An **Alarm** indicates a problem, but the TriStar continues to operate. The problem must be recognized and repaired as soon as possible. The Alarms that can be displayed include the following:

- “Ths disconnected” — heat sink temperature sensor is open
- “Ths shorted” — heat sink temperature sensor short circuit
- “TriStar hot” — limiting output due to high heat sink temperature
- “Current limit” — limiting an overcurrent condition
- “Current offset” — current reading an offset greater than 1 amp
- “Battery sense” — battery voltage sense error
- “Batt Sense disc” — battery sense was working but is now disconnected
- “Uncalibrated” — calibration out of range – return to factory for calibration
- “RTS miswire” — sense wires are connected to the RTS terminal
- “HVD” — high voltage alarm in diversion mode
- “high d” — high duty cycle in diversion mode
- “miswire” — system wiring problem detected (outside the TriStar)
- “FET open” — FET’s should be closed but are open
- “P12” — check the TriStar power supply



NOTE: *If the RTS or battery sense wire is disconnected (or the wire is broken or loose) while working properly, a fault is indicated. However, if power is removed and the TriStar is restarted, the controller cannot detect the RTS or battery sense and there will no longer be an alarm or indication of a problem. If there is any question about the status of these attachments, use the Diagnostic displays to confirm that the battery sense or RTS is working correctly.*

4.3 Using the Diagnostic Data

A full set of operating information is displayed below the Fault and Alarm display screens. These values are real-time and can change while the screen is being displayed.

continued...

4.3 Using the Diagnostic Data *continued...*

Most of the information is self-explanatory. Some comments follow:

- Battery temperature is displayed only if a Remote Temperature Sensor is connected. If the RTS was connected and then failed, the display will indicate: "- - °C" (or - -°F)
- "**Battery**" voltage is measured at the controller terminals.
- The "**Battery sense**" display is the actual battery voltage (measured with the sense wires to avoid the voltage drop to the battery terminals). "valid" means the sense wires are connected and working correctly.
- The "**Solar**" voltage is measured at the solar input terminals. If in a PWM state, the voltage will be the average of solar Voc and battery voltages with the FET switches opening and closing.
- "**Last Eq**" displays the number of days since the last equalization cycle.
- "**TriStar**" temperature displays the heat sink temperature.

For the Load mode, some of the above display screens are not shown. The load voltage and current consumption are displayed.

5.0 System Settings

This set of display screens provides the following functions:

- confirm that the setup and DIP switches are correct
- provide version numbers and other information for tech support
- select a language or change the temperature display to °F

5.1 Locate System Settings

Scroll down to the display screen "TriStar Settings". Press the  pushbutton to reach the subset of displays with information about the TriStar settings and system setup. In addition to the controller configuration, hardware and software versions are identified to support troubleshooting. Use the up and down pushbuttons to scroll through the screens.

To return to the primary meter displays, press the up pushbutton until "to Return" is displayed. Press the  pushbutton as indicated to return to the main "TriStar Settings" display screen. Then scroll up to the top three operating displays.

5.2 Information Displayed

The first displays indicate the TriStar and meter software versions and the TriStar serial numbers. This identification will be important if technical support is required.

The remaining displays provide specific information that describes the operating mode, charging algorithm, and specific functions. If in a charging mode, the PWM or On-Off method of charging is identified.

This information can be used to confirm that the controller has been adjusted and setup as desired. If any of these values do not seem correct, review the TriStar controller manual and confirm the DIP switch positions.

5.3 Language and Temperature Selections

The bottom two display screens provide for selecting a language or different temperature units:

continued...

5.3 Language and Temperature Selections *continued...*

1. Change Language

One of four languages other than English can be selected for the meter displays. The available languages are French, German, Portuguese, and Spanish. After changing the language, all the displays will be in the selected language.

2. Change Temperature

The temperatures are displayed in °C, but can be changed to °F. Refer to the installation, Section 2.4, for more information.

Both of these selections can be changed at any time and without limit.

6.0 Troubleshooting the Meter

The TriStar meters take all the displayed information directly from the TriStar controller. There should not be any conflicts between the meter and the controller regarding data values. So the meter troubleshooting will focus on problems and faults with the meter itself.

6.1 Troubleshooting Steps

There is no display:

- the RJ-11 cable may be plugged into the wrong connector socket — move to the other socket on the meter (*refer to Figure 2.2*)
- the connector may be loose in the socket — remove and reconnect, press firmly until there is a “click”
- there may be a break in the cable wire (*see Section 6.2 below*)
- note that the TS-M (controller-mounted) version must be working correctly for the remote meter to work — troubleshoot the TS-M version first if both are installed
- battery voltage is below 9.0 volts (meter turns off)

LCD meter backlighting is dim or does not light:

- if there is enough ambient lighting in the room, the backlighting may not be noticeable
- below 12.7V the backlighting starts to dim in proportion to the battery voltage
- below 10V the meter will cycle the backlighting
- use a flashlight, if necessary, to see the display for troubleshooting

The chart in the manual does not match the meter display:

- the meter being used may not exactly match the charts in this manual due to software revisions
- if there are substantial differences between your meter display and the charts, either the wrong chart is being used, or the wrong controller operating mode was selected

Meter “settings” displayed do not match the TriStar manual:

- there may be slight differences due to revisions
- if some important setpoints displayed do not match the controller settings, it is likely that a DIP switch in the controller has been set in the wrong position (all meter information is taken directly from the controller)

Cannot return to the top displays or exit a display:

- follow the meter chart in this manual, and the arrows on the meter display
- the meter may not be able to move in the direction of the pushbutton being used — try other pushbutton directions until the display screens change
- as the display screens change, follow your progress using the meter charts
- at the bottom of “TriStar Settings” and “Diagnostics” it is necessary to scroll back up to the top and then return to the main path of display screens (see Section 4.1 or 5.1)

Does not respond to the pushbutton:

- press the pushbutton down harder — it will not break
- try the other pushbuttons to confirm one or more are working
- if the others work, this pushbutton may have dirt on the contact
- to clean: disconnect the power, remove the 2 phillips screws that fasten the meter to the cover plate, and remove the meter assembly from the yellow pad — clean the pushbutton contact and the circuit board contact area with alcohol and a cotton swab

Dirt is trapped between the display and the label window:

- disconnect power and remove the 2 phillips screws that fasten the meter to the cover plate
- remove the meter assembly from the cover plate
- clean the label window and replace the meter assembly

Cable or connector has been damaged:

- if “Morningstar Corp” remains in the first display screen, there is a cable wiring fault
- if “Communications Error” is displayed, there is a broken cable wire
- see the notes below for repair

6.2 Repair RJ-11 connection

The meter connecting cable is a standard 6-conductor telephone cable with RJ-11 modular connectors. If the cable or connectors are damaged, the cable can either be repaired or replaced.

A standard flat 6-wire phone cable should be used. With the RJ-11 connectors, the cable assembly appears as shown in the diagram below:



A 4-wire cable can also be used for shorter distances.

7.0 Warranty

LIMITED WARRANTY

The TriStar meters (versions TS-M and TS-RM) are warranted to be free from defects in material and workmanship for a period of FIVE (5) years from the date of shipment to the original end user. Morningstar will, at its option, repair or replace any such defective products.

CLAIM PROCEDURE

Before requesting warranty service, check the Operator's Manual to be certain that there is a fault with the meter. Return the defective product to your authorized Morningstar distributor with shipping charges prepaid. Provide proof of date and place of purchase.

To obtain service under this warranty, the returned products must include the model, serial number and detailed reason for the failure, the panel type, array size, type of batteries and system loads. This information is critical to a rapid disposition of your warranty claim.

Morningstar will pay the return shipping charges if the repairs are covered by the warranty.

WARRANTY EXCLUSIONS AND LIMITATIONS

This warranty does not apply under the following conditions:

- Damage by accident, negligence, abuse or improper use.
- Unauthorized product modification or attempted repair
- Damage occurring during shipment

THE WARRANTY AND REMEDIES SET FORTH ABOVE ARE EXCLUSIVE AND IN LIEU OF ALL OTHERS, EXPRESS OR IMPLIED. MORNINGSTAR SPECIFICALLY DISCLAIMS ANY AND ALL IMPLIED WARRANTIES, INCLUDING, WITHOUT LIMITATION, WARRANTIES OF MERCHANTABILITY AND FITNESS FOR A PARTICULAR PURPOSE. No Morningstar distributor, agent or employee is authorized to make any modification or extension to this warranty.

MORNINGSTAR IS NOT RESPONSIBLE FOR INCIDENTAL OR CONSEQUENTIAL DAMAGES OF ANY KIND, INCLUDING BUT NOT LIMITED TO LOST PROFITS, DOWNTIME, GOODWILL OR DAMAGE TO EQUIPMENT OR PROPERTY.

1098 Washington Crossing Road, Washington Crossing, PA 19877
USA Tel 215-321-4457 Fax 215-321-4458
Email: info@morningstarcorp.com www.morningstarcorp.com

8.0 Technical Specifications

These specifications are for the TriStar LCD meters only.

METER

- Voltage accuracy
12/24V: $\leq 0.1\% \pm 50\text{ mV}$
48V: $\leq 0.1\% \pm 100\text{ mV}$
- Self-consumption
7.5 mA (not backlit)
42.5 mA with backlighting
- Limit of meter
9.3 V
- Display limit
9.0 V
- LCD temp. rating
 -20°C to $+70^{\circ}\text{C}$
(extended temperature rated)

BACKLIGHTING

- Time backlit
5 minutes
- Backlighting current
35 mA
(28 hours backlighting = 1 Ah)
- Start to dim backlight
< 12.7 V
- Start to cycle backlight
< 10.0 V

MECHANICAL

- Mounting plate dimensions
116 x 116 mm (4.56 x 4.56 inch)
- Plate material
powder coated steel
- Meter weight
0.23 kg / 0.5 lb - TS-M
0.18 kg / 0.4 lb - TS-RM
- Connector type
RJ-11 (6 pin)
- TS-M cable
0.13m (5 inch) - 6 conductor
- TS-RM cable
30m (98.4 ft) - 6 conductor
- Cable temperature
60°C rating

ENVIRONMENTAL

- Ambient temperature
 -40°C to $+60^{\circ}\text{C}$ (display may
darken temporarily below -20°C)
- Storage temperature
 -55°C to $+85^{\circ}\text{C}$
- Humidity
5-95% (NC)

Specifications subject to change without notice.

Designed in the U.S.A.

Assembled in Taiwan.

MS-ZMAN-TSM01-A (MAY 03)

Notes

Notes

Notes
